

# SOT-323 Plastic-Encapsulate Diode

## AZ23C2V7W-AZ23C39W ZENER DIODE

### FEATURE

- 符合 RoHS 环保要求
- 符合 Y 系列, 1.5mm 高度封装
- 符合 AEC-Q101 汽车级可靠性要求
- ΔX: 符合 IEC 60749-10 环保要求
- 符合 IEC 60749-10 环保要求
- 符合 IEC 60749-10 环保要求

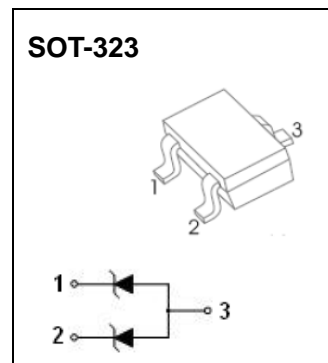

### Maximum Ratings (Ta=25°C unless otherwise specified)

Characteristic	Symbol	Value	Unit
Forward Voltage @ I <sub>F</sub> = 10mA	V <sub>F</sub>	0.9	V
Power Dissipation	P <sub>d</sub>	200	mW
Thermal Resistance (Junction to Ambient)	R <sub>θJA</sub>	625	°C/W
Maximum Junction Temperature	T <sub>j</sub>	150	°C
Storage Temperature Range	T <sub>stg</sub>	-55 to 150	°C

## ELECTRICAL CHARACTERISTICS

T<sub>a</sub>=25°C unless otherwise specified

Type Number	Marking Code	Zener Voltage Range (note 1)	Maximum Zener Impedance (note 2)		Typical Temperature Coefficient	Min Reverse Voltage (note 1)
		@ I <sub>ZT</sub> =5.0mA	Z <sub>ZT</sub> @I <sub>ZT</sub> =5.0mA	Z <sub>ZK</sub> @I <sub>ZK</sub> =1.0mA		@I <sub>R</sub> =0.1 A
		V <sub>Z</sub> (X)	Ω	Ω	μV/°C	V <sub>R</sub> (X)
AZ23C2V7W	KD1	2.5-2.9	83	500	-0.065	—
AZ23C3V0W	KD2	2.8-3.2	95	500	-0.060	—
AZ23C3V3W	KD3	3.1-3.5	95	500	-0.055	—
AZ23C3V6W	KD4	3.4-3.8	95	500	-0.055	—
AZ23C3V9W	KD5	3.7-4.1	95	500	-0.050	—
AZ23C4V3W	KD6	4.0-4.6	95	500	-0.035	—
AZ23C4V7W	KD7	4.4-5.0	78	500	-0.015	—
AZ23C5V1W	KD8	4.8-5.4	60	480	+0.005	0.8
AZ23C5V6W	KD9	5.2-6.0	40	400	+0.020	1.0
AZ23C6V2W	KDA	5.8-6.6	10	200	+0.030	2.0
AZ23C6V8W	KDB	6.4-7.2	8.0	150	+0.045	3.0
AZ23C7V5W	KDC	7.0-7.9	7.0	50	+0.050	5.0
AZ23C8V2W	KDD	7.7-8.7	7.0	50	+0.055	6.0
AZ23C9V1W	KDE	8.5-9.6	10	50	+0.065	7.0
AZ23C10W	KDF	9.4-10.6	15	70	+0.065	7.5
AZ23C11W	KDG	10.4-11.6	20	70	+0.070	8.5
AZ23C12W	KDH	11.4-12.7	20	90	+0.075	9.0
AZ23C13W	KDI	12.4-14.1	25	110	+0.080	10.0
AZ23C15W	KDJ	13.8-15.6	30	110	+0.080	11.0
AZ23C16W	KDK	15.3-17.1	40	170	+0.090	12.0
AZ23C18W	KDL	16.8-19.1	50	170	+0.090	14.0
AZ23C20W	KDM	18.8-21.2	50	220	+0.090	15.0
AZ23C22W	KDN	20.8-23.3	55	220	+0.090	17.0
AZ23C24W	KDO	22.8-25.6	80	220	+0.090	18.0
AZ23C27W	KDP	25.1-28.9	80	250	+0.090	20.0
AZ23C30W	KDQ	28-32	80	250	+0.090	22.5
AZ23C33W	KDR	31-35	80	250	+0.090	25.0
AZ23C36W	KDS	34-38	90	250	+0.090	27.0
AZ23C39W	KDT	37-41	90	300	+0.110	29.0

Notes: 1. Short duration test pulse used to minimize self-heating effect

2. f=1\H:

# Typical Characteristics

Zener Characteristics ( $V_z$  Up to 10 V)

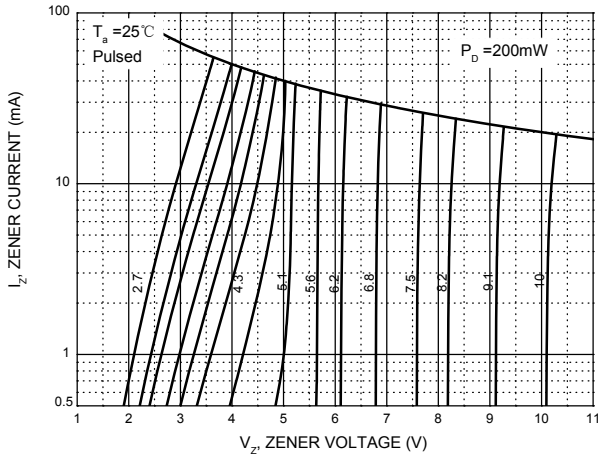

Zener Characteristics (11 V to 43 V)

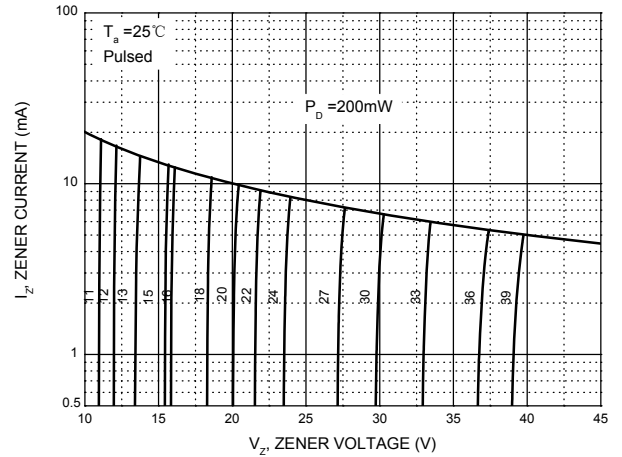

Temperature Coefficients

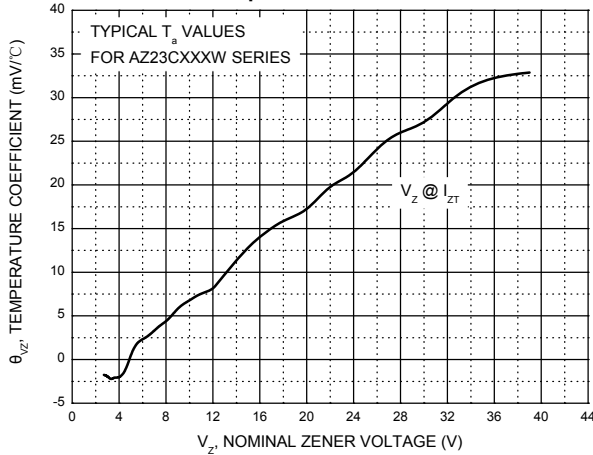

Typical Leakage Current

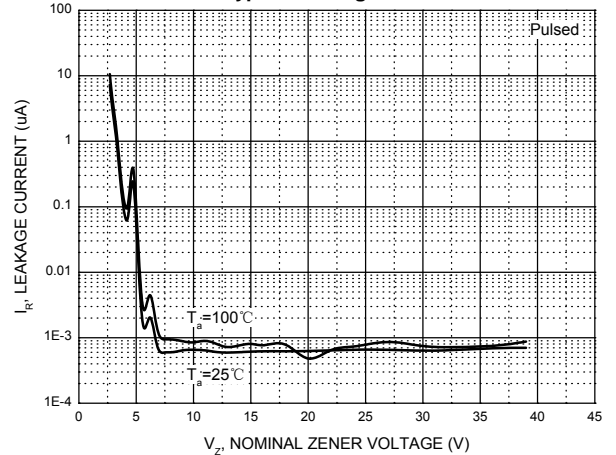

Typical Capacitance

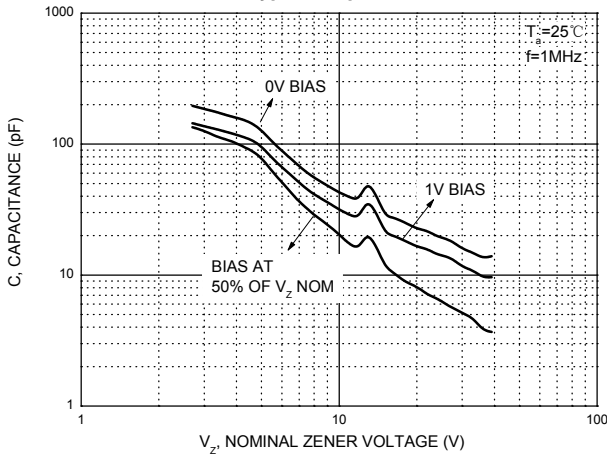

Effect of Zener Voltage on Zener Impedance

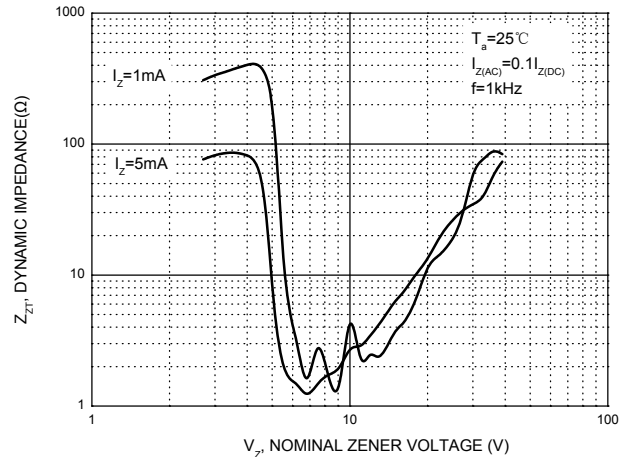

Power Derating Curve

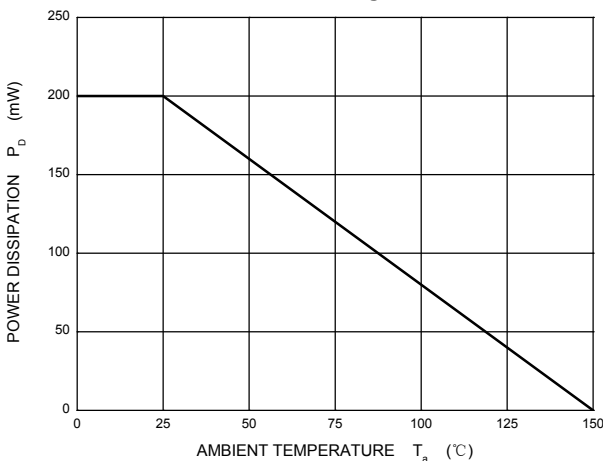

## SOT-323 Package Outline Dimensions

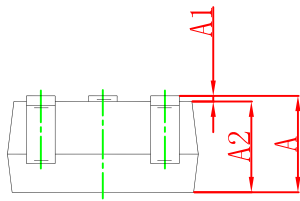
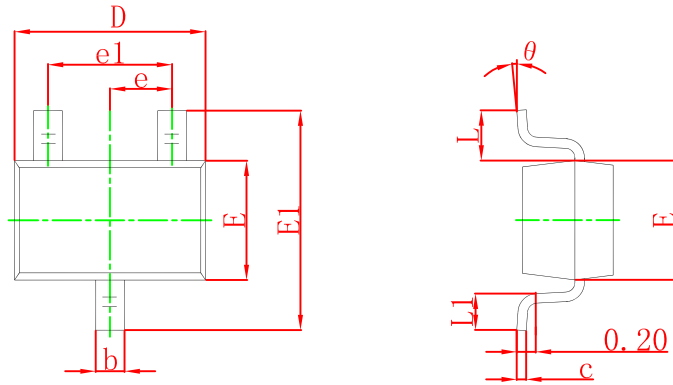

Symbol	Dimensions In Millimeters		Dimensions In Inches	
	Min	Max	Min	Max
A	0.900	1.100	0.035	0.043
A1	0.000	0.100	0.000	0.004
A2	0.900	1.000	0.035	0.039
b	0.200	0.400	0.008	0.016
c	0.080	0.150	0.003	0.006
D	2.000	2.200	0.079	0.087
E	1.150	1.350	0.045	0.053
E1	2.150	2.450	0.085	0.096
e	0.650 TYP		0.026 TYP	
e1	1.200	1.400	0.047	0.055
L	0.525 REF		0.021 REF	
L1	0.260	0.460	0.010	0.018
θ	0°	8°	0°	8°

## SOT-323 Suggested Pad Layout

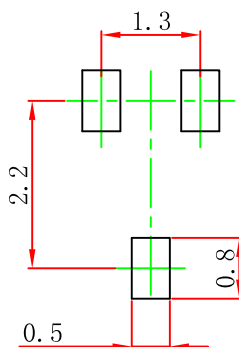

Note:

1. Controlling dimension: in millimeters.
2. General tolerance:  $\pm 0.05$ mm.
3. The pad layout is for reference purposes only.

### NOTICE

JCET reserve the right to make modifications, enhancements, improvements, corrections or other changes without further notice to any product herein. JCET does not assume any liability arising out of the application or use of any product described herein.

# SOT-323 Tape and Reel

## SOT-323 Embossed Carrier Tape

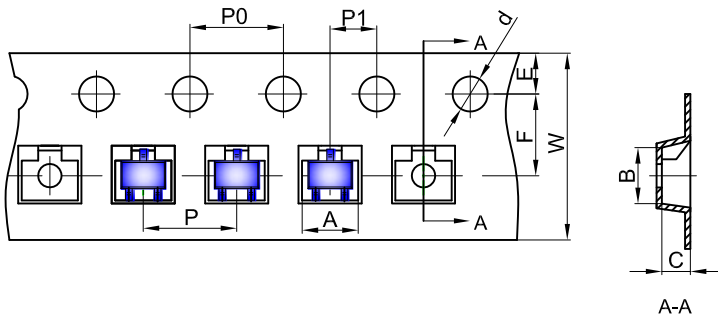

**Packaging Description:**  
 SOT-323 parts are shipped in tape. The carrier tape is made from a dissipative (carbon filled) polycarbonate resin. The cover tape is a multilayer film (Heat Activated Adhesive in nature) primarily composed of polyester film, adhesive layer, sealant, and anti-static sprayed agent. These reeled parts in standard option are shipped with 3,000 units per 7" or 17.8cm diameter reel. The reels are clear in color and is made of polystyrene plastic (anti-static coated).

Dimensions are in millimeter										
Pkg type	A	B	C	d	E	F	P0	P	P1	W
SOT-323	2.25	2.55	1.19	Ø1.55	1.75	3.50	4.00	4.00	2.00	8.00

## SOT-323 Tape Leader and Trailer

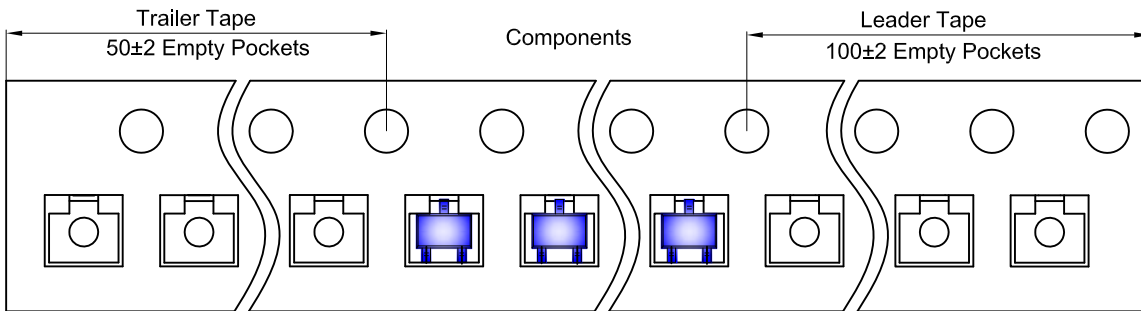

## SOT-323 Reel

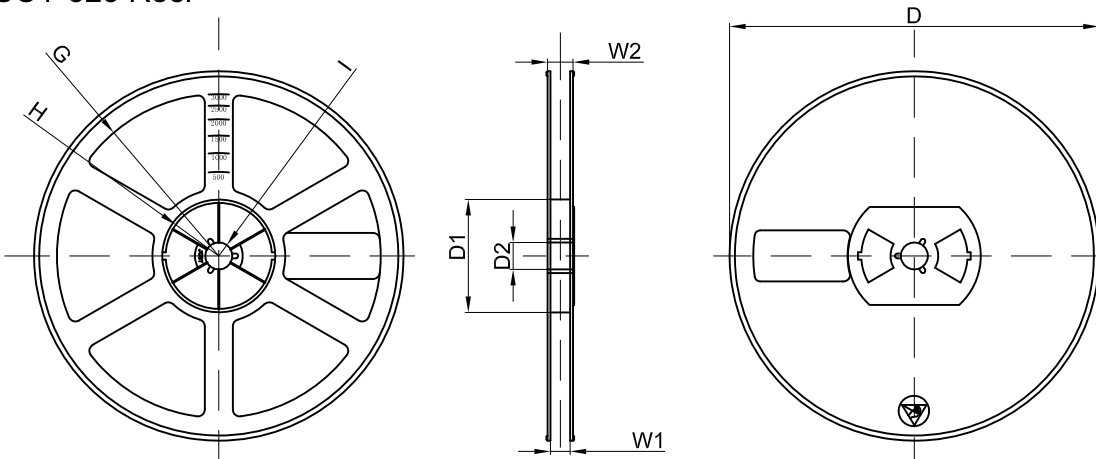

Dimensions are in millimeter								
Reel Option	D	D1	D2	G	H	I	W1	W2
7" Dia	Ø178.00	54.40	13.00	R78.00	R25.60	R6.50	9.50	12.30

REEL	Reel Size	Box	Box Size(mm)	Carton	Carton Size(mm)	G.W.(kg)
3000 pcs	7 inch	45,000 pcs	203×203×195	180,000 pcs	438×438×220	